

LME-541-#

Single channel pyroelectric detector

Description:

single channel; TO39 housing; large chip size; low Micro; OpAmp; current mode; feedback 24 GOhm;



Housing:

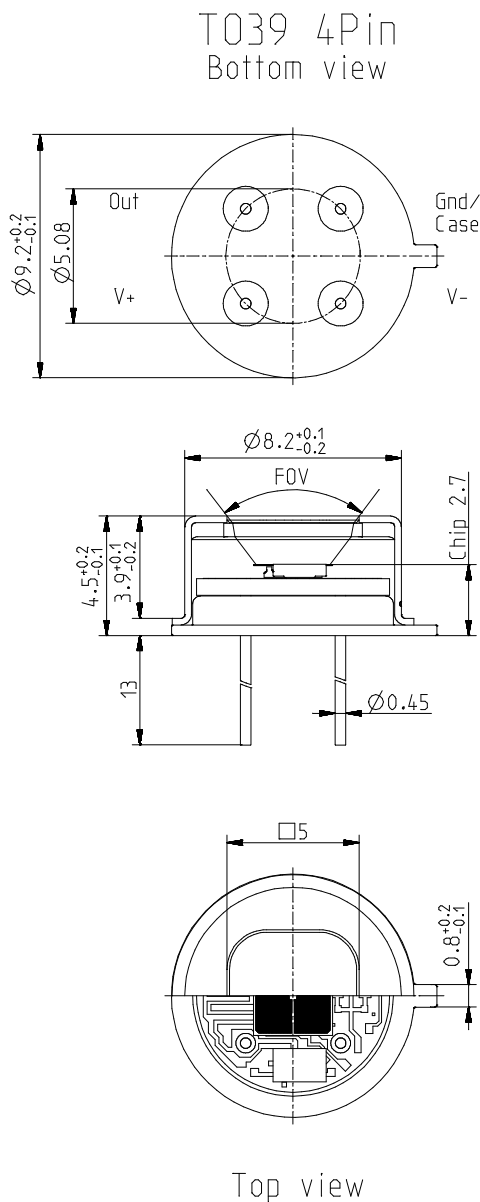

Pin Assigment:

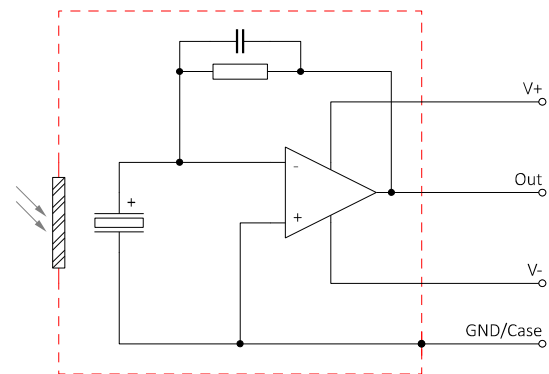

Maximum current between Case and the "Case"-Pin 10 mA!

Frequency Response:

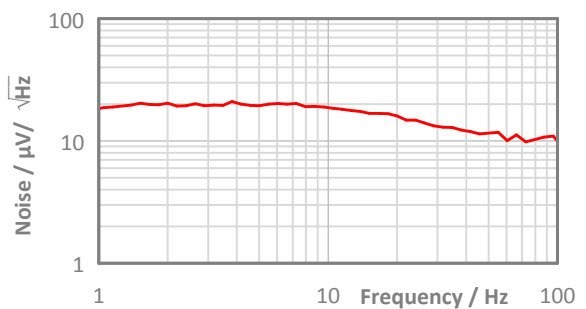
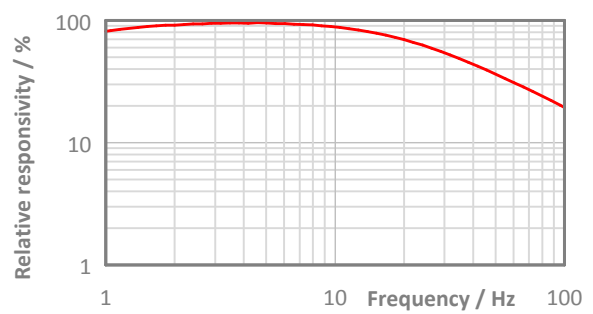

LME-541-#

Single channel pyroelectric detector

Test Circuit:

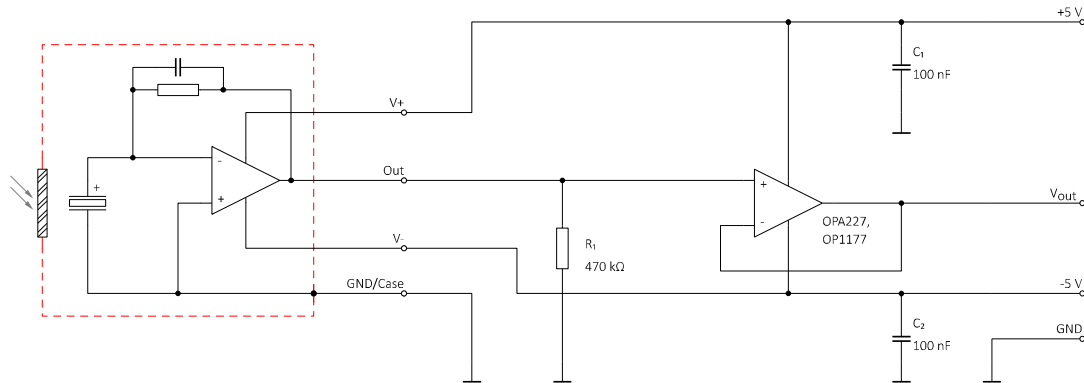

Parameters:

Aperture size	nom	□ 5.0 mm
Element size / type	nom	3.0 × 3.0 mm ² lithium-tantalate with black layer
Thermal time constant	typ	200 ms
Feedback resistor	nom	24 GΩ ±10 %
Feedback capacitor	nom	0.2 pF ±0.1 pF
Polarity	nom	Negative signal by positive IR flux change
Voltage responsivity (rms) {500 K, 10 Hz, 25 °C, without filter/window}	min	28,000 V/W
Noise density (rms) {10 Hz, BW 1 Hz, 25 °C}	max	25 μV/√Hz
Detectivity {500 K, 10 Hz, 1 Hz, 25 °C, without filter/window}	typ	4.7E+08 cmVHz/W
Acceleration response {5 ... 200 Hz}	typ	300 μV/g; g = 9.81 m/s ²
CMOS operational amplifier	nom	OpAmp2
Supply voltage V+ - V-	max	16 V
Operating supply voltage V+ / V-		+2.2 ... 8.0 V / -2.2 ... -8.0 V
Recommended supply voltage V+ / V-	nom	V+ = +5 V; V- = -5 V
Supply current {output load 1 MΩ}	max	150 μA
Offset voltage {25 °C; output load 1 MΩ}		-5 mV ... +5 mV
Optimal output load	nom	470 kΩ
Absolute output current	max	±0.4 mA
Operating / Storage temperature	nom	-40 ... +85 °C
IR filter		All InfraTec windows and filters are available (except KBr and CsI). Customized filters upon request.
Filter sizes	nom	Rectangular filters: (5.25 × 5.25) mm +0/-0.05 mm Circular filters: ø6.5 mm ±0.1 mm Standard thickness: 0.50 mm +0.2/-0.1 mm Thickness range 0.70 ... 1.10 mm on request
Field of View	min	CaF ₂ or BaF ₂ ; 0.4 mm thick: 60° Silicon substrate; 0.5 mm thick: 70°

InfraTec reserves the right to change these specifications at any time without notification.